

A Pentair Company

ULTRX[®]

Rack Angles (Type RA)
 Angulos del Estante (Tipo RA)
 Rasterprofile (Typ RA)
 Angulos Para Rejilla (Type RA)

Hoffman Enclosures Inc.
 2100 Hoffman Way
 Anoka, MN 55303-1745
 (763) 422-2211 Tel
 www.hoffmanonline.com

Pentair Electronic Packaging
 170 Commerce Drive
 Warwick, RI 02886
 (401) 732-3770
 www.pentair-ep.com

Canada
 Hoffman-Schroff
 111 Grangeway Avenue, Suite 504
 Scarborough, Ontario M1H 3E9
 (416) 289-2770 Fax (416) 289-2883
 1-800-668-2500 (Canada only)

Germany
 Schroff GmbH
 Langensalber Str. 96-100
 75334 Straubenhardt
 49 (07082) 794-0 Fax 49 (07082)
 794-200
 www.schroff.de

Great Britain
 Schroff UK Ltd.
 Maylands Avenue
 Hemel Hempstead, Herts HP2 7DE
 44 (01442) 240471 Fax 44 (01442) 213508
 www.schroff.co.uk

Sweden
 Schroff Scandinavia AB
 Box 2003
 12821 Skarpnäck
 46 08683 61 00 Fax 46 08683 61 99
 www.schroff.se

France
 Schroff Sas
 Z.I., 4 rue du Marais
 67660 Betschdorf
 33 03 88 90 64 90 Fax 33 03 88 90 64 88
 www.schroff.fr

Italy
 Schroff srl
 Viale Milano, 119
 21013 Gallarate (Varese)
 39 0331 79 40 03 Fax 39 0331 79 34 50

Singapore
 Hoffman-Schroff Pte. Ltd.
 #01-6871 German Centre
 25 International Business Park
 Singapore 609916
 65 5 62-78 90 Fax 65 5 62-78 99

Japan
 Schroff K.K.
 Nisso No. 13 Bldg. 4F
 2-5-1 Shinyokohama
 Kohoku-Ku, Yokohama shi
 Kanagawa 222-0033
 81 (045) 476-02 81 Fax 81 (045) 476-02
 89

Finland
 Schroff Scandinavia AB
 Perasentie 8
 03100 Nummela
 358 09 222 68 00 Fax 358 09 222 38 86

Norway
 Schroff Scandinavia AB
 Bjoernerudveien 24
 1266 Oslo
 47 022 76 33 60 Fax 47 022 76 33 69

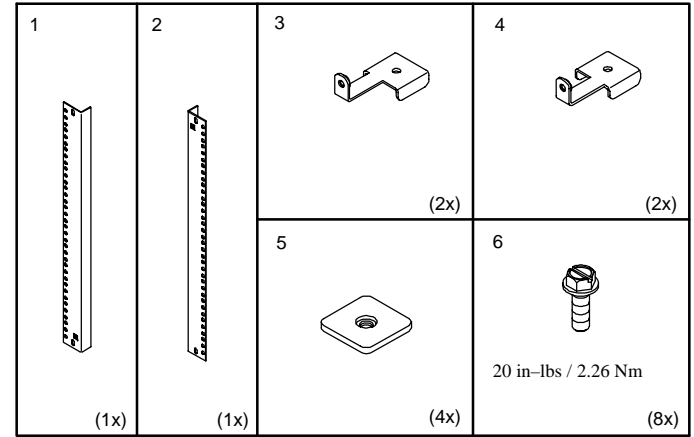

NOTE: Order clip-nut package separately.
 (A-N1032) (A-NM5 metric)
 Items 3, 4: Adjustable front to back.

HINWEIS: Bestellen Sie das Clipmutterpaket
 separat. (metrisch A-NM5) (U.S. A-N1032)
 Position 3, 4: Von vorne aus einstellbar.

REMARQUE: Commander un paquet
 d'attaches-écrous. (A-N1032 Séparément)
 (A-NM5 en système métrique)
 Repère 3, 4: Réglable d'avant en arrière.

NOTA: Pida el paquete de sujetadores-tuercas.
 (A-N1032 separadamente) (A-NM5 métrico)
 Número 3, 4: Ajustable desde el frente hacia la
 parte posterior.

